



# MOBILIARIO URBANO 2016



**Montaxes Os Ancares**  
Telf. 982 101 200

Travesía de Bagueixos S/N - Pd. O Ceao 27298 LUGO  
[www.montaxesosancares.com](http://www.montaxesosancares.com)

**BANCOS**



**Montaxes Os Ancares**  
Telf. 982 101 200

Travesía de Bagueixos S/N - Pol. O Ceao 27298 LUGO

[www.montaxesosancares.com](http://www.montaxesosancares.com)



## LUGO MADERA TÉCNICA

Sin mantenimiento  
60% madera reciclada  
40% polímero reciclado  
Larga durabilidad / resistencia a golpes  
No se astilla  
Resistencia a las inclemencias climáticas

## SANTIAGO MADERA TÉCNICA



## LUGO POLÍMERO RECICLADO

100% RECICLABLE 

Sin mantenimiento  
100% material reciclado y reciclable  
Larga durabilidad, no se astilla ni agrieta  
Resistencia a las inclemencias climáticas



## SANTIAGO POLÍMERO RECICLADO



## LUGO MADERA

Pies en fundición dúctil, acabados con pintura oxirón al horno.  
Madera de guinea tratada y barnizada con lasur a poro abierto.  
Opcional en madera certificada.



Disponible con patas de aluminio



-3m



SILLA



## MADERA TRATADA

Pies en fundición dúctil, acabados con pintura oxirón al horno.  
Madera de pino autoclave clase IV, certificada.

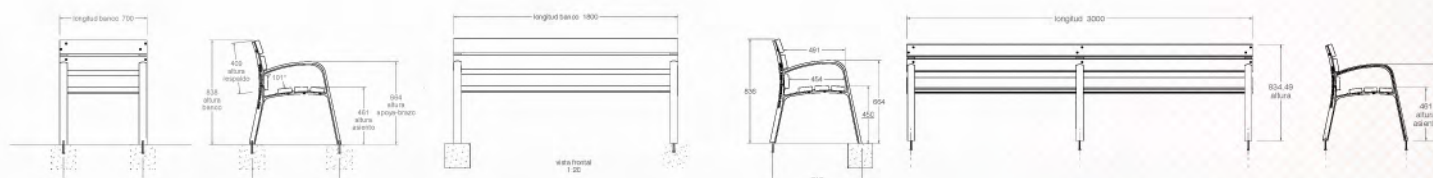





### **LUGO POLIETILENO**

Disponible en 6 colores: rojo, azul, verde, amarillo, gris y marrón



### **LUGO ACERO**

## SANTIAGO MADERA Y PATAS ALUMINIO



Pies de aluminio anodizado AG3  
Madera de guinea tratada, de 40x70mm y barnizada con lasur a poro abierto  
Opcionalmente en madera certificada\*

SILLA ▶



Producto certificado por FSC  
FSC certified product  
Produit certifié par FSC

## SANTIAGO FUNDICIÓN

Totalmente en fundición dúctil  
Acabado con pintura oxiron al horno

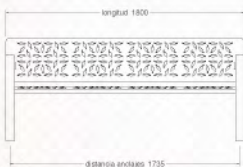

# SANTIAGO ALUMINIO TOTAL

Listones y pies en aluminio anodizado AG3



SILLA



3m

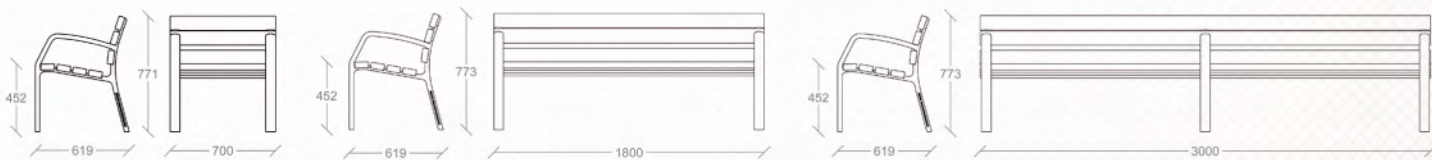



## SANTIAGO MADERA

Pies en fundición dúctil, acabados con pintura oxirón al horno.  
Madera de guinea tratada y barnizada con lasur a poro abierto.  
Opcional en madera certificada.



SILLA ▶



3 mts



**RESPALDO CORTO**



**MADERA TRATADA**

Pies en fundición dúctil, acabados con pintura oxirón al horno.  
Madera de pino autoclave clase IV, certificada.

ron.

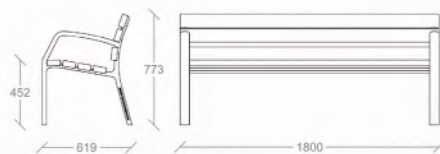
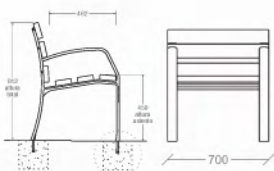

## BETANZOS

Madera de guinea tratada, de 60mm de espesor y barnizada con lasur a poro abierto. 4 posibles acabados de pies: ACERO INOXIDABLE PULIDO, ACERO CORTEN, ACERO GALVANIZADO, ACERO PINTADO.

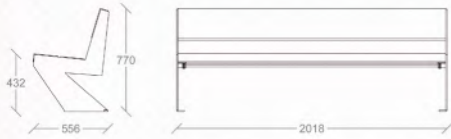

GALVANIZADO







## VIGO

Estructura galvanizada,  
Madera de guinea tratada, de 70mm de espesor y  
Barnizada con lasur a poro abierto.

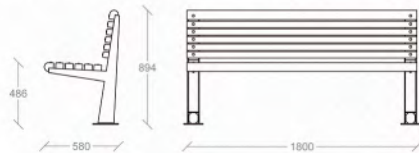

## ◀ FOZ

Estructura galvanizada,  
Madera de guinea tratada, de 70mm de espesor y  
Barnizada con lasur a poro abierto.



## SERIE O CAUREL

Pies de acero pintado  
Madera tropical

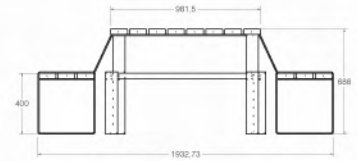

SILLA

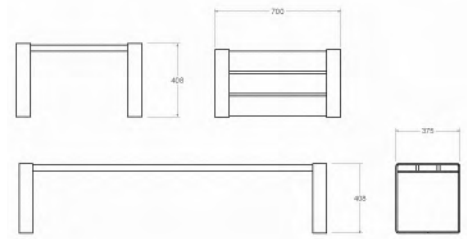

BANCO SIN RESPALDO



BANCO

## OROSO

Disponible en 2m y opcionalmente de 1,8m.

Pies en fundición y madera tropical

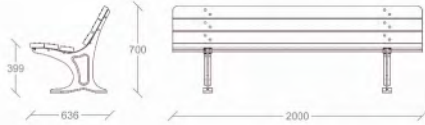

Producto certificado por FSC  
FSC certified product  
Produit certifié par FSC



## ◀ PADRÓN

Disponible en 2m y opcionalmente de 1,8m

Pies en fundición y madera tropical

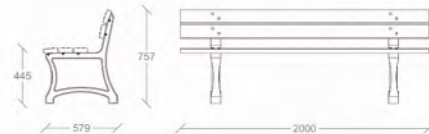

## MELIDE ▶

Pies en fundición y madera tropical

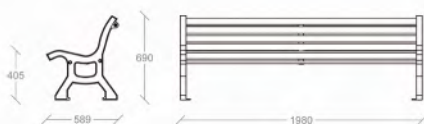





## ARZÚA

Pies en fundición y madera tropical



## MONFORTE

Pies en fundición y madera tropical

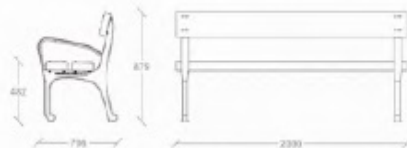

## NAVIA

Pies en fundición y madera tropical

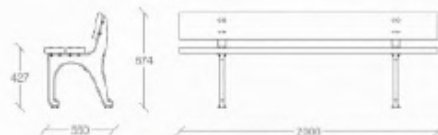



## AS PONTES

Pies en fundición y madera tropical

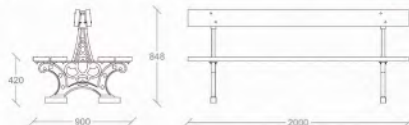

## ROMÁNTICO

Pies en fundición y madera tropical o madera tratada en autoclave



**DISPONIBLE MADERA TÉCNICA**

60% MADERA RECICLADA  
40% POLÍMERO RECICLADO

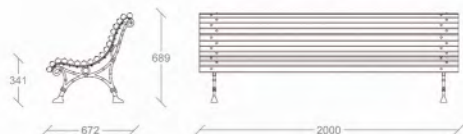

## ROMÁNTICO DOBLE

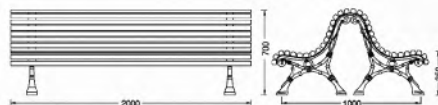

## PLAZA

Pies en fundición y madera tropical

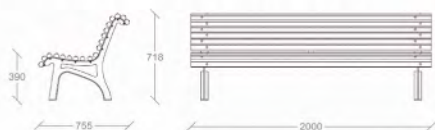





## ALLARIZ

Estructura galvanizada y madera tropical



## ALLARIZ METAL

Estructura galvanizada pintada en color negro

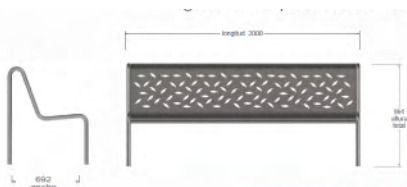

## FUNDICIÓN

Elaborado de fundición y pintado en negro



## RIBADEO

Estructura galvanizada

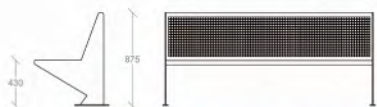

## ALLARIZ GALVANIZADO

Estructura galvanizada y pintado color plata

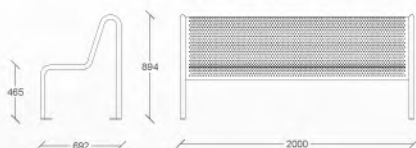

## PEDRAFITA A

Hormigón en blanco con armadura de acero galvanizado



## PEDRAFITA B

Hormigón en blanco con armadura de acero galvanizado

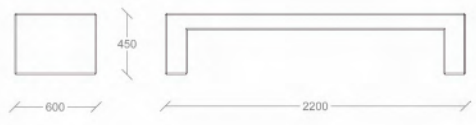

## PEDRAFITA C

Hormigón en blanco con armadura de acero galvanizado



**PICNIC OS ANCARES  
MADERA TRATADA**

Madera tratada en autoclave nivel IV

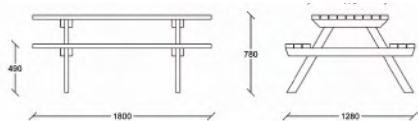

PAPELERAS MADERA TRATADA PAG. 28



**PICNIC OS ANCARES  
MADERA TROPICAL**

Madera tropical

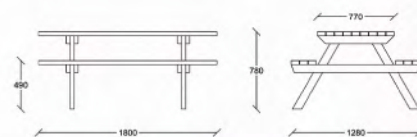

PAPELERAS MADERA TROPICAL PAG.28





# PAPELERAS



**Montaxes Os Ancares**  
**Telf. 982 101 200**

Travesía de Bagueixos S/N - Pol. O Ceao 27298 LUGO

[www.montaxesosancares.com](http://www.montaxesosancares.com)



## ◀ PRAZA

Estructura de acero galvanizado. Acabado pintura al horno. 3 Colores a escoger: marron corten, gris metalizado y oxiron negro

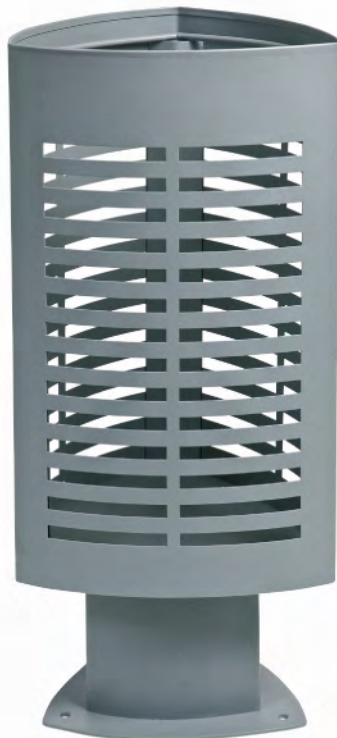
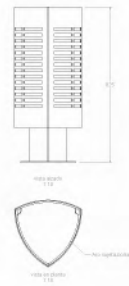

## BOULEVARD ▶

Estructura de acero galvanizado, tapa abatible y aro sujeta bolsas  
Pintura al horno. Capacidad 85L.

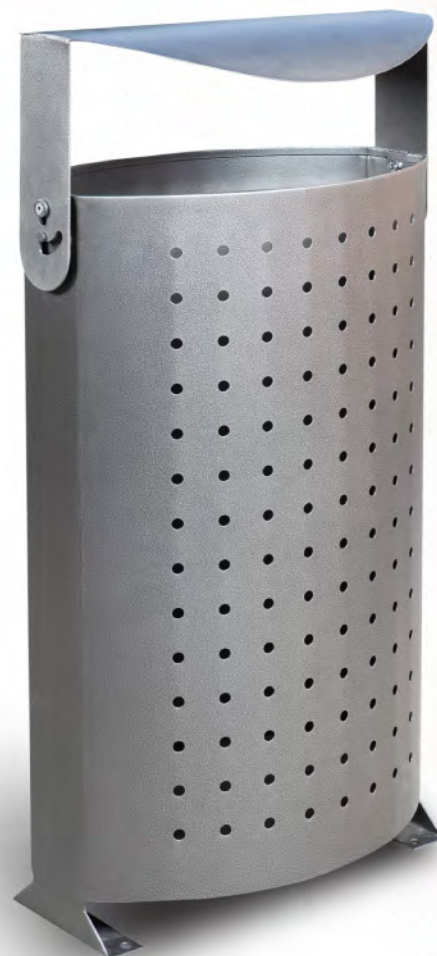
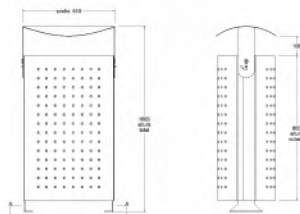

## ◀ CIRCULAR A

Chapa de acero galvanizada  
Cubeta interior extraíble. Capacidad 65L.  
Color negro



## CIRCULAR B ▶

Chapa de acero galvanizado con cierre  
Cubeta interior extraíble. Capacidad 65L.  
2 Colores a escoger: gris RAL9018 y oxirón negro



Oxirón negro

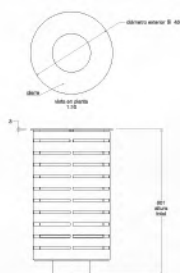



**ECO**

Polietileno con cerradura. capacidad 60L



RAL 3020



RAL 1021



RAL 5005



RAL 6029

100% RECICLABLE





RAL 7040



## MONUMENTAL PLÁSTICA

Polietileno con cerradura. capacidad 80L con cubeta

100% RECICLABLE 



RAL 6029



RAL 3020



RAL 5005



## AROS

Estructura acero pintado

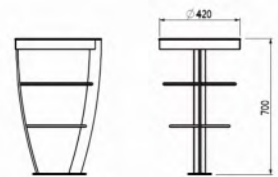

## NEO

Chapa de acero de 2mm pintada. Con cerradura  
Capacidad 75L con cubeta



## AVENIDA A

Chapa de acero galvanizada de 2mm pintada.  
Con cerradura. Capacidad 60L

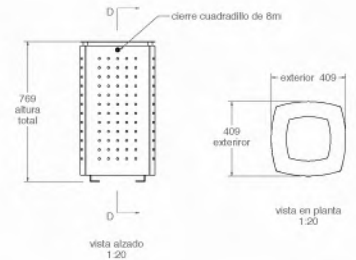

## AVENIDA B

Chapa de acero galvanizada de 2mm pintada  
y madera tropical. Con cerradura. Capacidad 60L

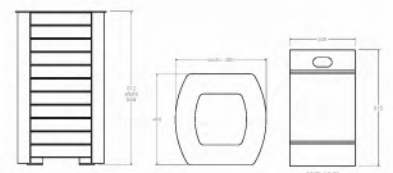





## BARCELONA FUNDICIÓN

Fundición Dúctil. Capacidad 60L

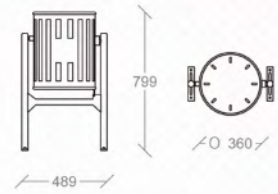

## MONUMENTAL FUNDICIÓN

Fundición Dúctil. Abatible. Capacidad 45L

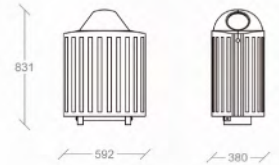

## BARCELONA SEMI FUNDICIÓN

Fundición Dúctil. Capacidad 31L

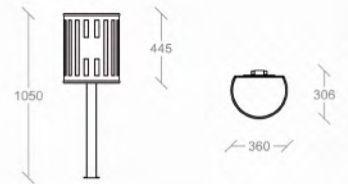

## PORTO

Fundición Dúctil. Capacidad 160L

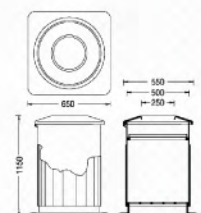



## CLÁSICA

Chapa de acero de 2mm pintada. Capacidad 40L

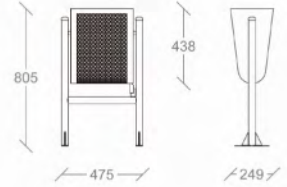

## RIBADEO

Chapa de acero galvanizada y pintada. Capacidad 60L

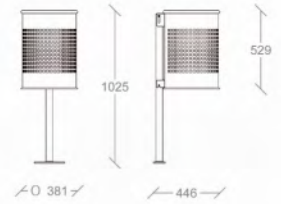

## INOX

Estructura acero inox. Capacidad 65L

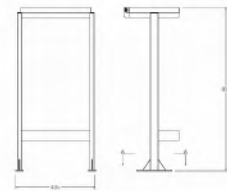

## ALAMEDA

Estructura acero pintado. Capacidad 65L con cubeta

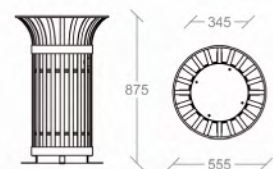



## O CAUREL

Estructura metálica lacada y madera tratada en autoclave.  
55L con aro sujeta bolsas. Disponible de 80L

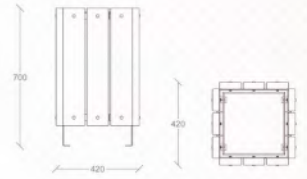

## O CAUREL TROPICAL

Estructura metálica lacada y madera tropical en autoclave.  
55L con aro sujeta bolsas. Disponible de 80L

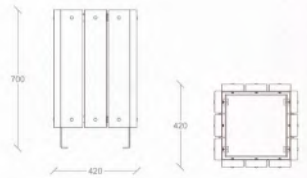

## OS ANCARES

Estructura metálica lacada y madera tratada en autoclave.  
40L con aro sujeta bolsas.

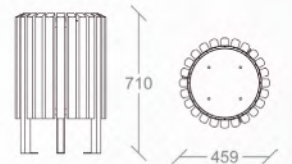

## OS ANCARES TROPICAL

Estructura metálica lacada y madera tropical en autoclave.  
40L con aro sujeta bolsas.

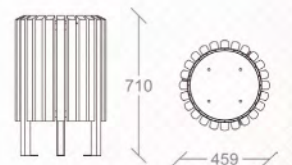



## BARCELONA METÁLICA

Galvanizada y lacada



▲  
Circular de 50/60 y 70l



▲  
Semicircular 30l



▲  
Circular con cenicero



▲  
Circular con sombrero

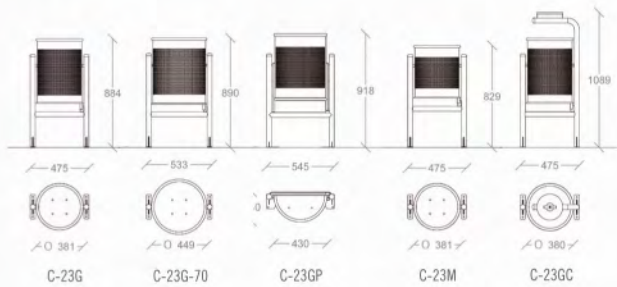

## SERIE ESPECIAL

Lacada en marrón corten o gris oscuro metalizado



## BARCELONA INOX

Circular 60l y Semicircular 30l

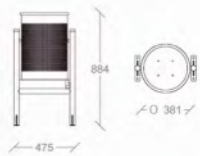



## HISTÓRICA

Plancha embutida y lacada al horno. Capacidad 40l.  
 Disponible versión con sombrero, doble y de pared

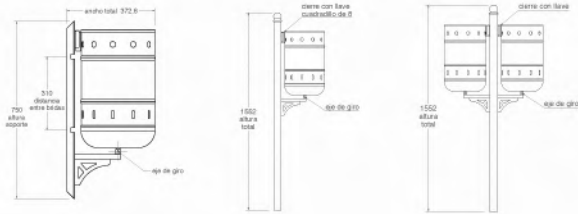

## PLÁSTICA

Poliétileno. Capacidad 55l.  
 Disponible poste galvanizado.

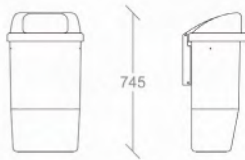

## PARQUE

Estructura de acero pintado y madera tropical. Capacidad 40l

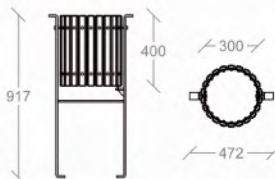

# JARDINERAS



**Montaxes Os Ancares**  
Telf. 982 101 200

Travesía de Bagueixos S/N - Pol. O Ceao 27298 LUGO

[www.montaxesosancares.com](http://www.montaxesosancares.com)





## RECTANGULAR 1M

Fundición pintada en oxirón.  
100x35x40cm

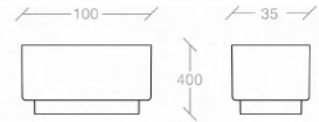

## RECTANGULAR 75CM

Fundición pintada en oxirón.  
75X45X40cm

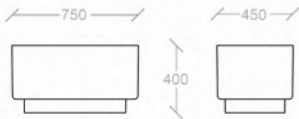

## CUADRADA

Fundición pintada en oxirón.  
70X70X40cm

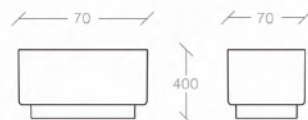



## CIRCULAR

Fundición pintada en oxirón.  
90 o 135cm de diámetro

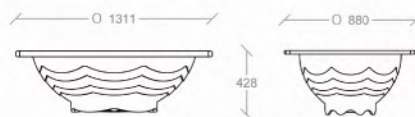

## CLÁSICA

Fundición pintada en oxirón.  
100X35X40cm



## TRIANGULAR

Fundición pintada en oxirón.  
107X54X59cm



## PRAZA A

Fundición pintada en oxirón.  
58X75cm

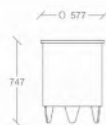

## PRAZA B

Fundición pintada en oxirón.  
86X55cm

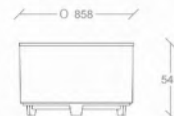

## MINI

Fundición pintada en oxirón.  
85X45cm

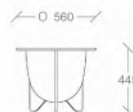



## NEO

Estructura de acero pintada al horno.  
78x78x60cm

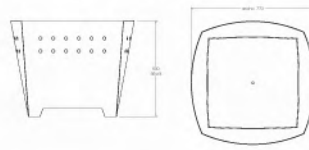

## DECORADA

Estructura de acero pintada al horno.  
Personalizable, dibujos, logos, textos.  
50x50x50cm

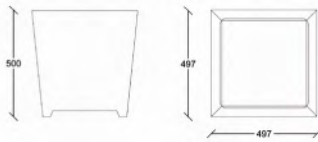

## CORTEN A

Estructura de acero corten oxidado y acero inox. Sin base  
105x62cm

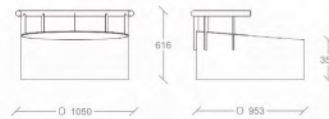

## CORTEN B

Estructura de acero corten oxidado  
87x63cm







## OS ANCARES

Estructura galvanizada y madera tropical de Guinea.  
Medidas 67X54cm.

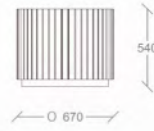

## O CAUREL

Estructura galvanizada y madera tratada en autoclave.  
Medidas 60X53cm.

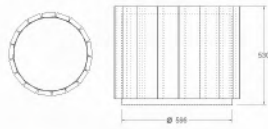

## MANZANEDA

Estructura galvanizada y madera tratada en autoclave.  
Medidas 51X30cm y 120x50cm.

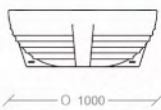
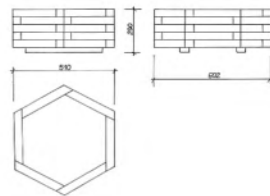

## POLIETILENO

Disponible en 5 colores  
Medidas 100X38cm .



RAL 6029

RAL 3020

RAL 1021

RAL 5005



# FUENTES



**Montaxes Os Ancares**

**Telf. 982 101 200**

Travesía de Bagueixos S/N - Pol. O Ceao 27298 LUGO

[www.montaxesosancares.com](http://www.montaxesosancares.com)



## NEO ADAPTADA

Acero inox y acero pintado. Pulsadores temporizados

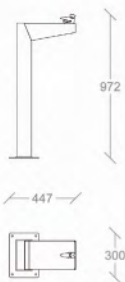
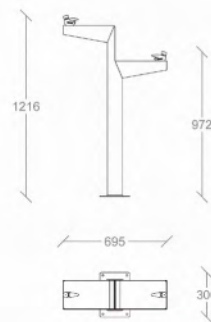

## NEO

Acero inox y acero pintado. Pulsador temporizado



## NEO DOG

Acero inox y acero pintado. Pulsadores temporizados.  
Para personas y mascotas







## INOX

Estructura totalmente realizada en Inox.  
Pulsador temporizado.

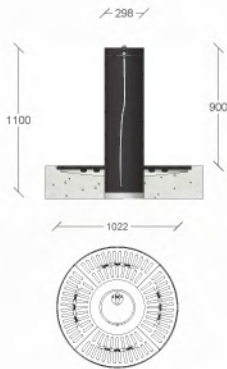
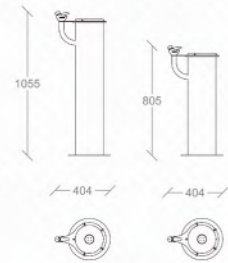

## PRAZA

Estructura acero pintado y cubeta en inox.  
Pulsador temporizado.

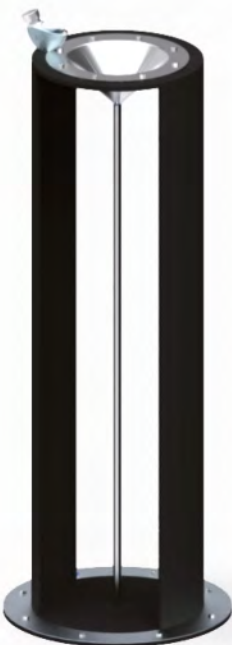

## DECO

Estructura acero pintado e inox.  
Pulsador temporizado.

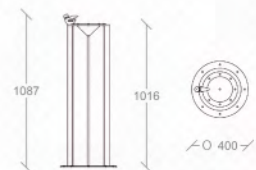

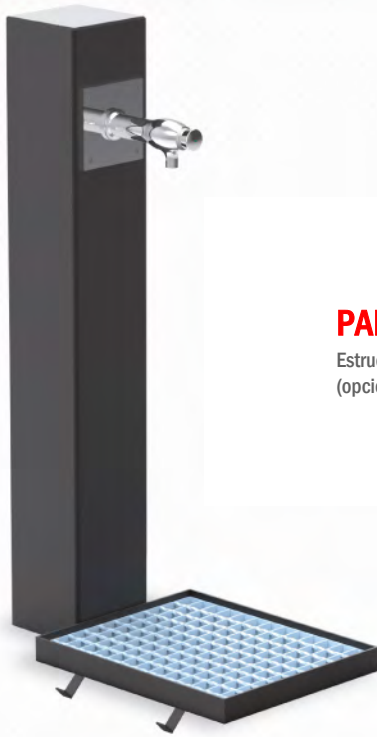

## PARQUE A

Estructura de acero pintado y reja de acero galvanizado (opcional en fundición). Pulsador temporizado

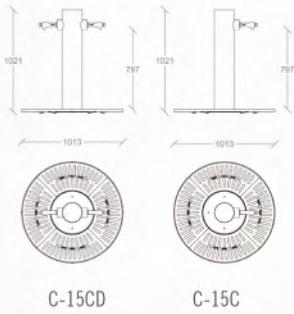
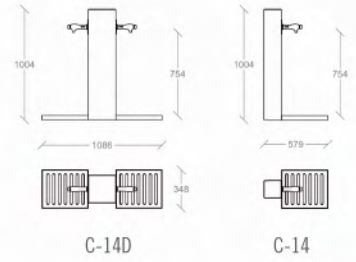

## PARQUE B

Estructura de acero pintado y reja de acero galvanizado. Pulsador temporizado



## PARQUE C

Estructura de acero pintado y reja de acero galvanizado. Pulsador temporizado

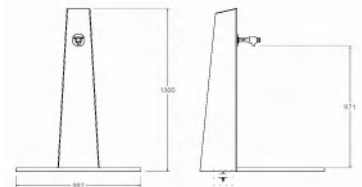



## ◀ INFANTIL

Fundición con grifo de chorro continuo

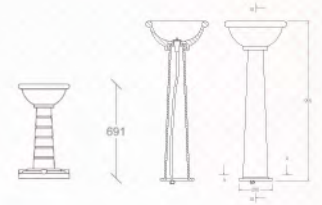

**OPCIONAL GRIFO DE PIE**



## ROMÁNTICA

Fundición con pintada en oxirón.  
Disponible con 1,2,3 o 4 pulsadores.

**OPCIONAL PEANA HORMIGÓN**

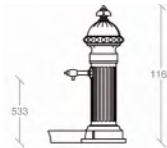

## ◀ PORTAL

Fundición pintada en oxirón

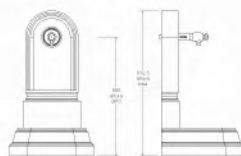

## ◀ MONUMENTAL

Fundición pintada en oxirón

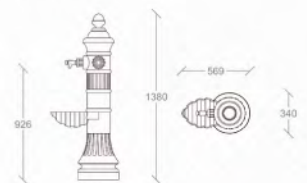

## GRIFO TEMPORIZADO

En latón o cromado, temporizado a 7 segundos



# ALCORQUES



**Montaxes Os Ancares**  
Telf. 982 101 200

Travesía de Bagueixos S/N - Pdl. O Ceao 27298 LUGO

[www.montaxesosancares.com](http://www.montaxesosancares.com)

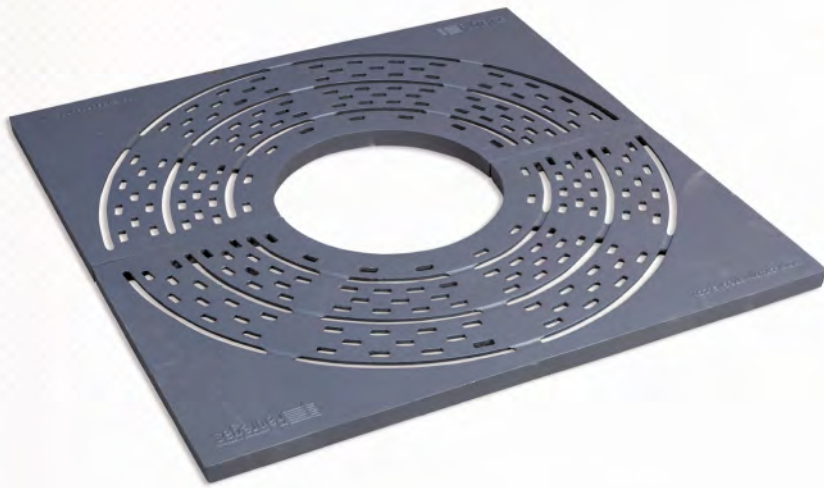

## PRAZA A

Fundición con acabado oxirón.  
Disponible en 80x80 y 100x100cm

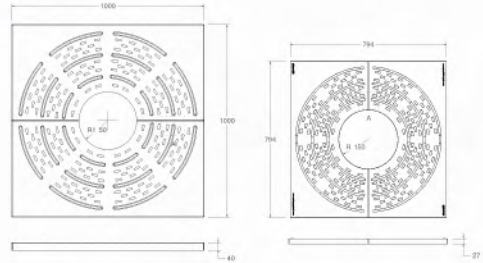

## PRAZA B

Fundición con acabado oxirón negro.  
Disponible en 80x80 y 100x100cm

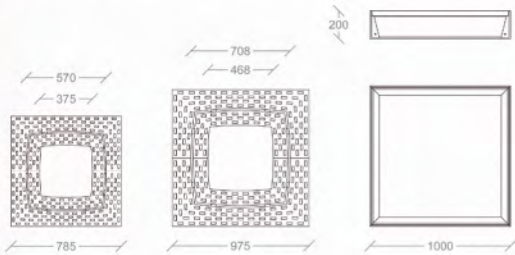
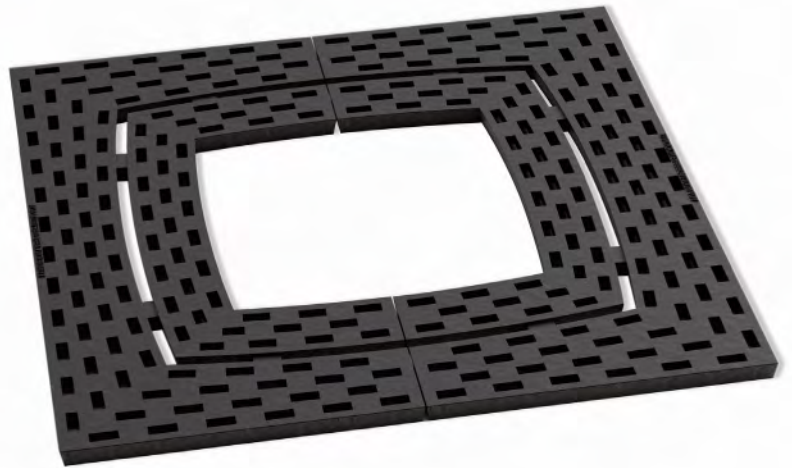

## PRAZA C

Fundición con acabado oxirón negro.  
Disponible en 100x100cm

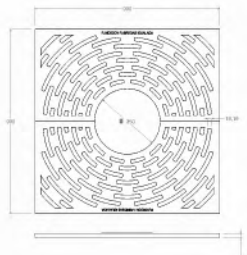

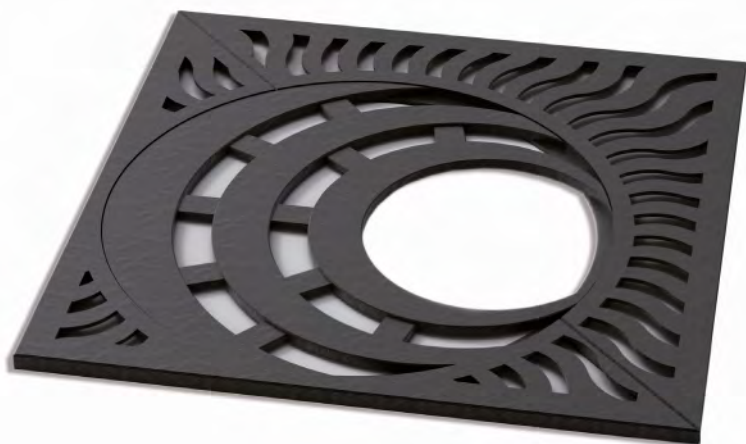

## NEO

Fundición con acabado oxirón negro.  
Disponible en 100x100cm

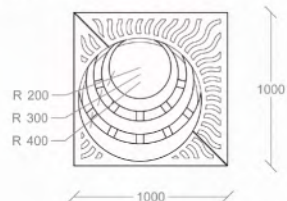

## CORTEN A

Fundición oxidada tipo corten. Formada por 4 piezas.  
Disponible en 80X80, 100x100, 120X120, 100X140,  
120X140 y 140X140 cm

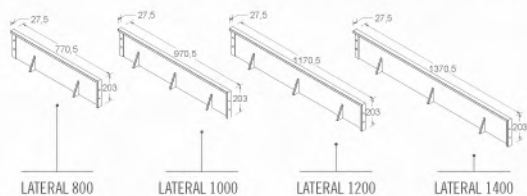

## CORTEN B

Fundición oxidada tipo corten. Formada por 4 piezas.  
Disponible en 100 y 120cm de diámetro.





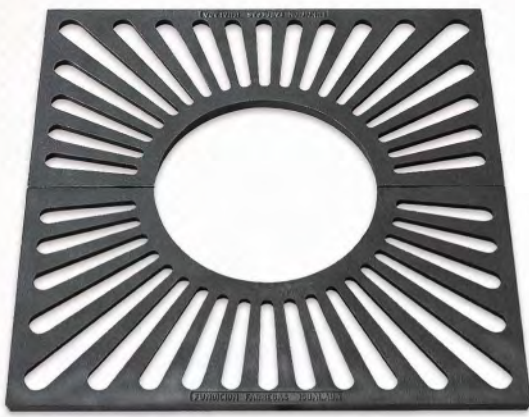

## CLÁSICO CUADRADO A

Fundición con acabado oxirón.  
 Disponible en 80x80 y 100x100cm

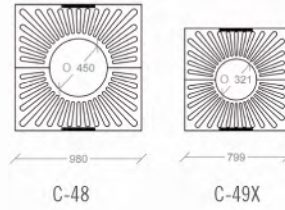

## CLÁSICO CUADRADO B

Fundición con acabado oxirón.  
 Disponible en 120x120cm

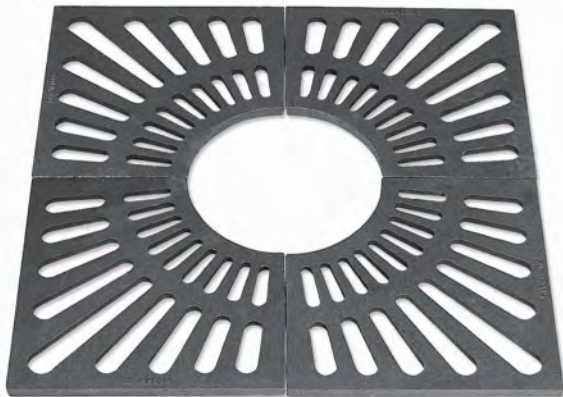
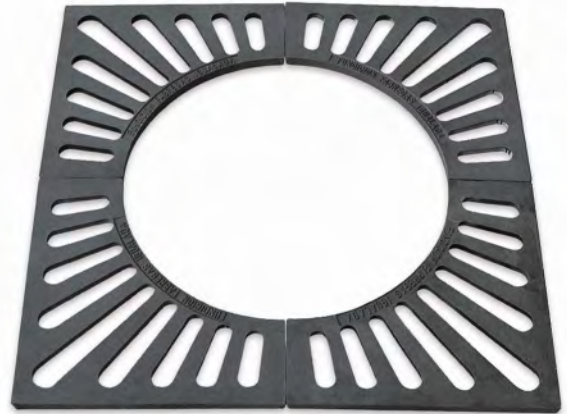
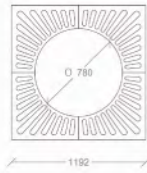

## CLÁSICO CUADRADO C

Fundición con acabado oxirón.  
 Disponible en 120x120cm



## GALVANIZADO

Acero galvanizado de 3cm de altura  
 Disponible en 50x50, 60x60, 70x70, 80x80,  
 90x90, 100x100, 110x110 y 120x120cm

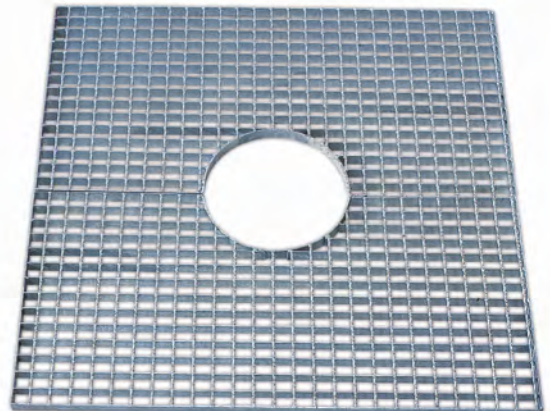
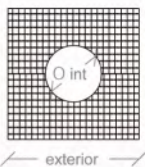



## BOULEVARD

Fundición con acabado oxirón negro.  
Disponible en 100x100cm



## DECORATIVO

Fundición con acabado oxirón negro.  
Disponible en 120x120cm con 4 registros para riego.

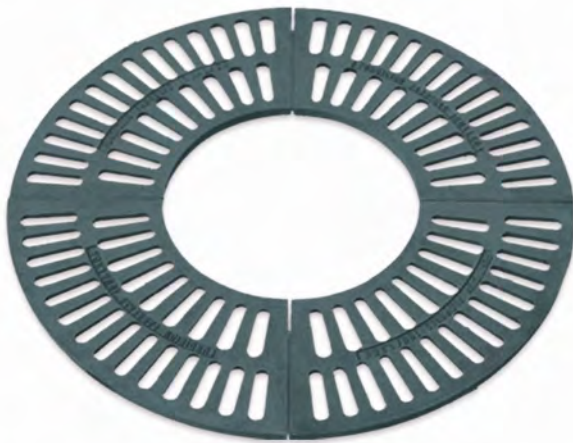
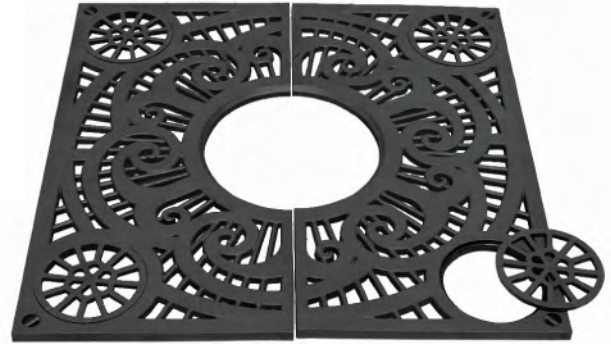
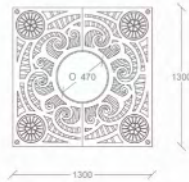

## CLÁSICO CIRCULAR A

Fundición con acabado oxirón.  
Disponible en 100 y 120cm de diámetro.

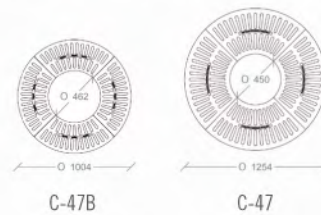

## CLÁSICO CIRCULAR A

Fundición con acabado oxirón.  
Disponible en 120cm de diámetro.

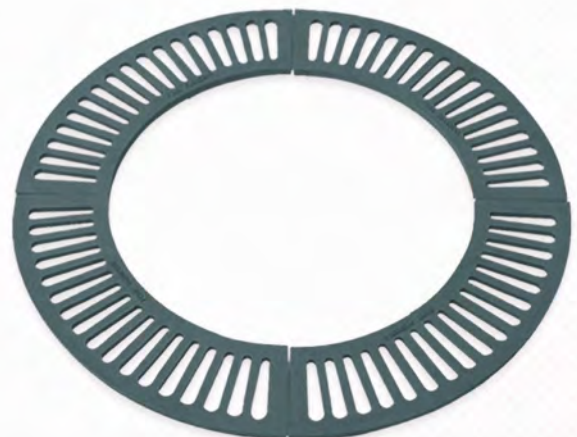
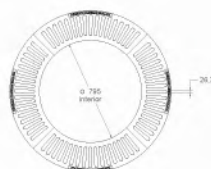

# PILONAS



**Montaxes Os Ancares**

**Telf. 982 101 200**

Travesía de Bagueixos S/N - Pdl. O Ceao 27298 LUGO

[www.montaxesosancares.com](http://www.montaxesosancares.com)





100% RECICLABLE

EMPIEZA A DEFORMARSE  
APLICÁNDOLE UNA  
FUERZA DE 150 Kgrs.

FLEXIBLE HASTA 20°  
SIN SUFRIR DAÑOS

### POLIELITENO A

(Para empotrar)

Absorbe impactos de vehículos y recupera la verticalidad al 100%  
Flexible hasta 20° sin daños, recuperando la posición completamente  
Flexión inteligente: no empieza a flexar hasta aplicarle cargas superiores a 150 kgs

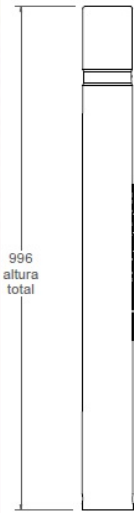

996  
altura  
total



### POLIELITENO B

(Para atomillar)

Absorbe impactos de vehículos y recupera la verticalidad al 100%  
Flexible hasta 20° sin daños, recuperando la posición completamente  
Flexión inteligente: no empieza a flexar hasta aplicarle cargas superiores a 150 kgs



**FACIL RECAMBIO  
SIN OBRA CIVIL**



## FLEX POLIURETANO

**EMPIEZA A DEFORMARSE  
APLICANDOLE UNA  
FUERZA DE 70 Kgrs.**

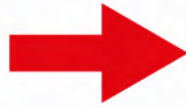

**FLEXA TOTALMENTE  
Y SIEMPRE RECUPERA SU  
POSICIÓN INICIAL.**

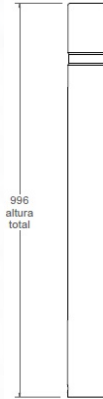

Combinación plástica con base de poliuretano  
Absorbe cualquier impacto de vehículos y recupera la verticalidad al 100%  
Sin sufrir daños ni desperfectos  
Sin mantenimiento, sin oxidación, resistente al U.V  
Incorpora banda reflectante



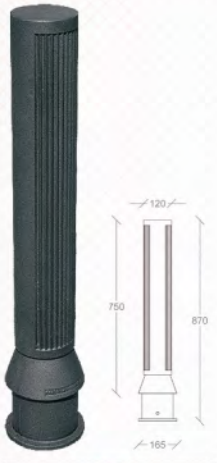

**SANTIAGO**



**ORTIGUEIRA**

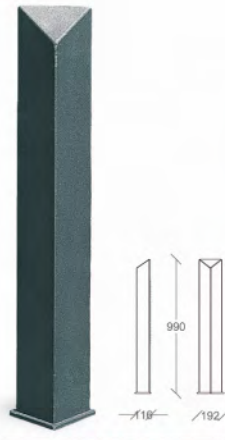

**LUGO**



**OROSO**



**RIBADEO**

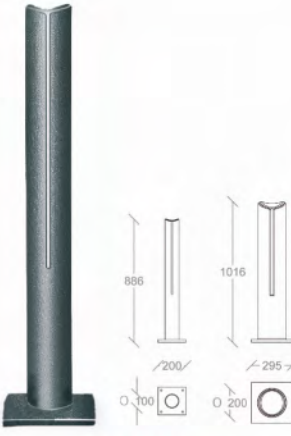

**BAIONA**

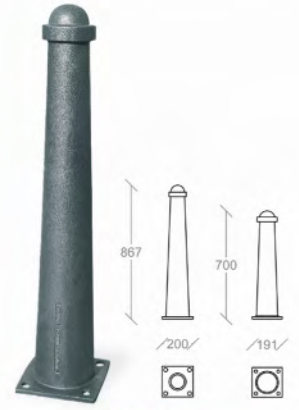

**FARO**

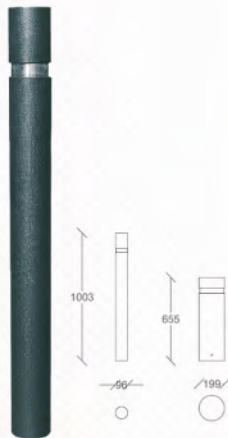

**BARCELONA A**



**BARCELONA B**

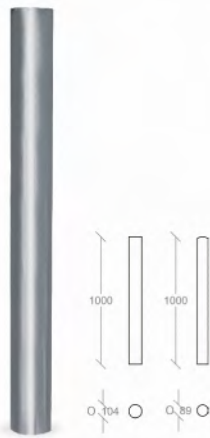

**TUBO INOX**

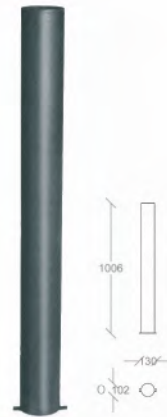

**TUBO**

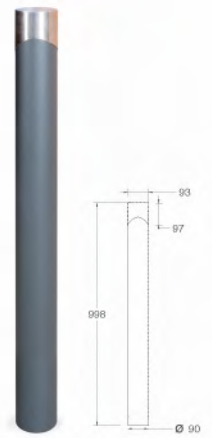

**TUBO NEO**



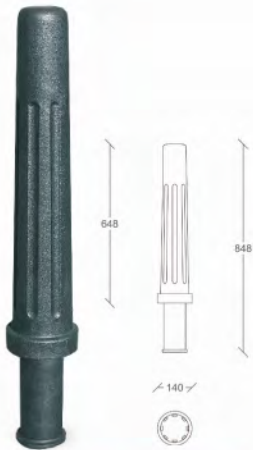

**PADRÓN A**

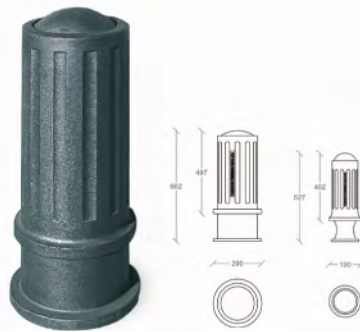

**PADRÓN B**

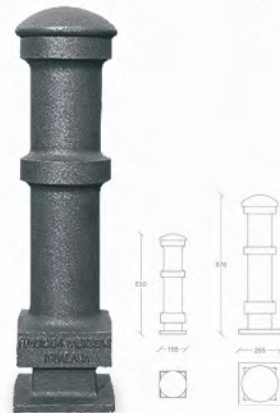

**MONUMENTAL**

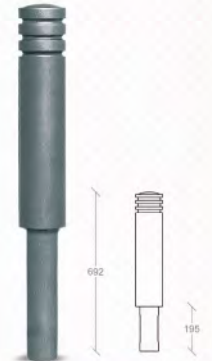

**A CORUÑA**



**BETANZOS**

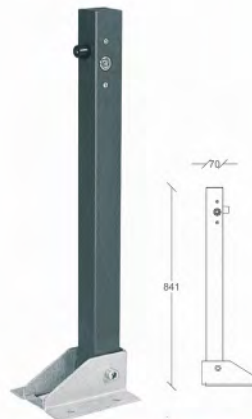

**PARKING ABATIBLE**

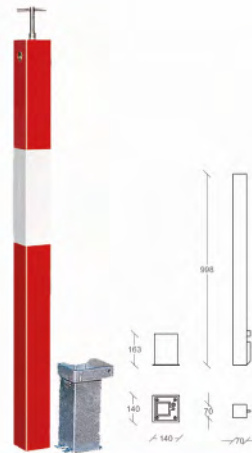

**PARKING EXTRAÍBLE**



**BARCELONA EXTRAÍBLE**

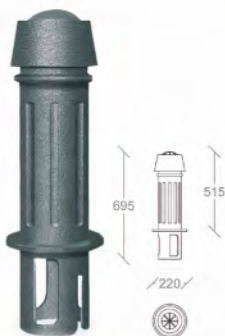

**TEO**

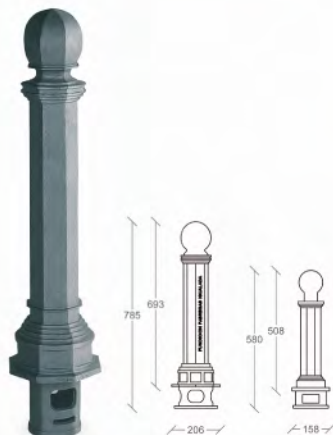

**MONFORTE**



**PADRÓN FLEXIBLE**



**MADRID**



**BURELA**

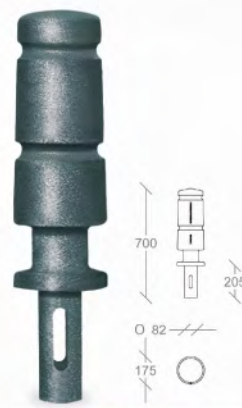

**TUI  
TUI**



**PORTO A**



**PORTO B**



**PORTO C**

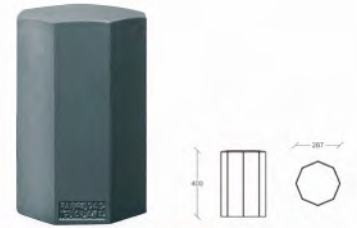

**NIGRÁN**



**BOLA**



**AMARREA**



**AMARRE B**



**BASE DESMONTABLE SIN TAPA**



**BASE DESMONTABLE CON TAPA**

Compatible con las pilonas:



Compatible con las pilonas:



# OTROS EQUIPAMIENTOS

## APARCABICIS ONDA



## APARCABICIS GALVANIZADO 5 PLAZAS

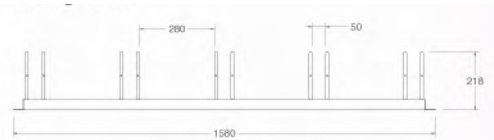

## APARCABICIS GALVANIZADO 6 PLAZAS

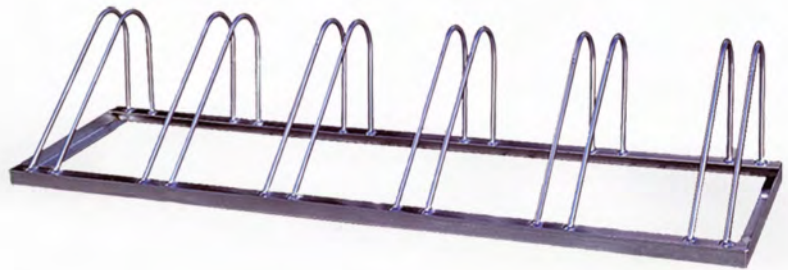

## APARCABICIS ALTO GALVANIZADO 7 PLAZAS



## ▲ BARCELONA

Galvanizado o Inox

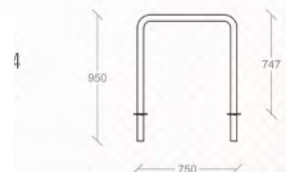



## CENICERO PARA ANCLAR



ADAPTABLES A TODO NUESTRO MOBILIARIO URBANO



## CENICERO PARA ACOPLAR INOX A y B

## DISPENSADOR BOLSAS CANINO

Acero lacado o Inox

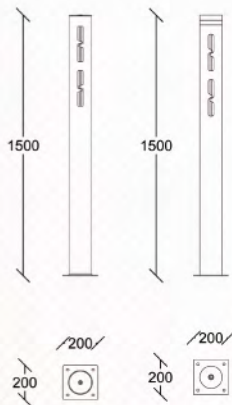

## FAROLAS Y BALIZAS



### FAROLA VILA

Fundición acabado oxirón

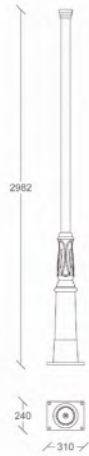

### FAROLA GALVANIZADA

Acero galvanizado

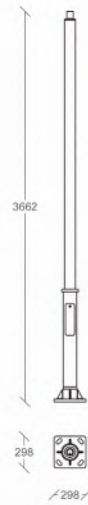

### KIT MONTAJE FAROLA

Placa de acero, 4 pernos, 8 arandelas y 8 tuercas

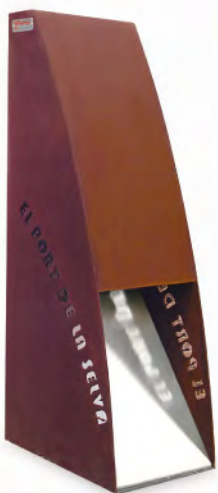

### BALIZA CORTEN

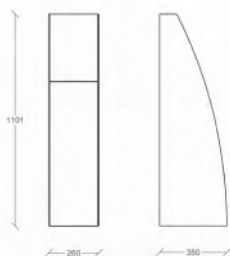

### BALIZA PILONA A

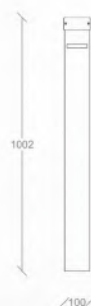

### BALIZA PILONA B



## DUCHAS , VALLAS Y DECELERADORES

### DUCHA CÍES

Acero Inox 316, 2 rociadores con pulsadores temporizados

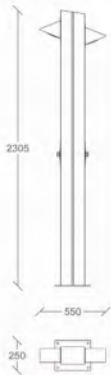

### DUCHA A RAPADOIRA

Acero Inox 316, 2 rociadores con pulsadores temporizados

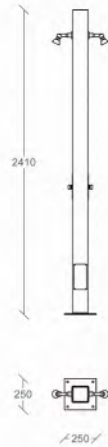

### FUENTE y LAVAPIES MIÑO

Acero Inox 316, 2 rociadores y 1 fuentes con 3 pulsadores temporizados

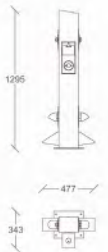

### VALLA PASEO

Acero pintado en oxirón



### VALLA POLIETILENO

100% Polietileno



### VALLA O CAUREL

Madera tratada en autoclave. Tramos de 200x100cm (incluye postes)



### VALLA OS ANCARES

Madera tratada en autoclave. Tramos de 200x100cm

### DECELERADORES A y B

Caucho con bandas reflectantes

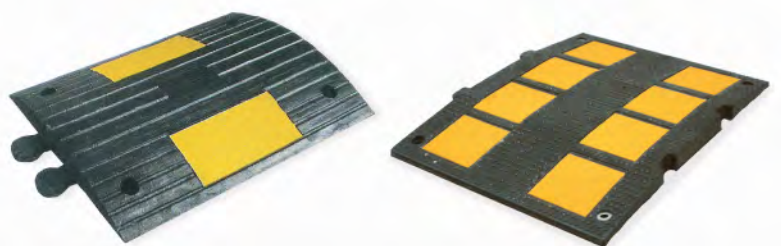
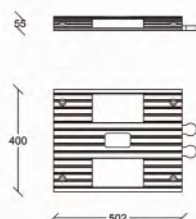





**Montaxes Os Ancares**

**Telf. 982 101 200**

Travesía de Bagueixos S/N - Pol. O Ceao 27298 LUGO

[www.montaxesosancares.com](http://www.montaxesosancares.com)